

# Technical data sheet

## Connection thread sealing ring, metric

Item number: 2030016

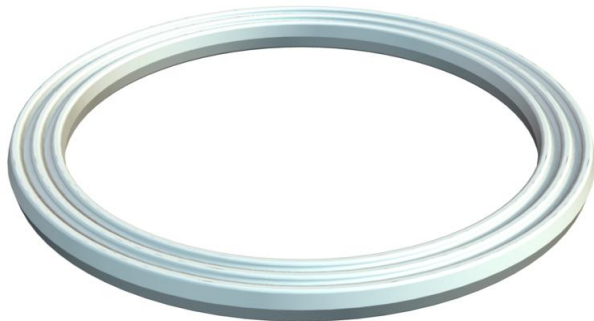

Connection thread sealing ring, suitable for all plastic cable glands, with metric thread according to DIN EN 60423 or ISO 68. The internal diameters of the sealing rings are designed in such a way that they can be pre-mounted in a captive manner.



PE Polyethylene

### Master data

Item number	2030016
Type	107 F M25 PE
Description 1	Connection thread sealing ring
Manufacturer	OBO
Dimension	M25
Material	Polyethylene
Smallest sales unit	100
Unit of quantity	Piece
Weight	0.038 kg
Weight unit	kg/100 pc.

### Dimensions

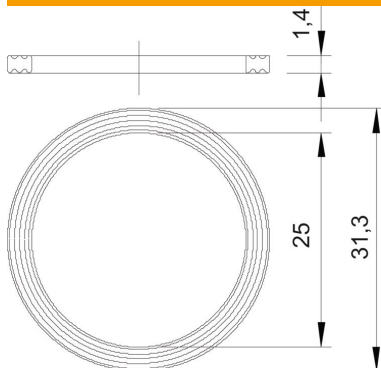

Dimension D1	31.3 mm
Dimension D2	25 mm
Dimension t	1.4 mm

### Technical data

Version for	Flat sealing ring
Suitable for metric thread dimension	25

# Technical data sheet

Connection thread sealing ring, metric

Item number: 2030016



## Technical data

Inner diameter	25 mm
----------------	-------