

Tehnicki list

Reduktor, PG-navoj

Broj artikla: 2030756



Adapter, PG-unutrašnji i spoljašnji navoj prema 40430.



PA poliamid

Matični podaci

Broj artikla	2030756
Tip	107 R PG16-11 PA
Oznaka 1	Reducir
Proizvođač	OBO
Dimenzija	PG16-PG11
Boja	svetlo siva; RAL 7035
Materijal	Poliamid
Smallest sales unit	50
Jedinica količine	Komad
Weight	0,48 kg
Jedinica težine	kg/100 pari

Tehnicki list

Reduktor, PG-navoj

Broj artikla: 2030756



Dimenzije

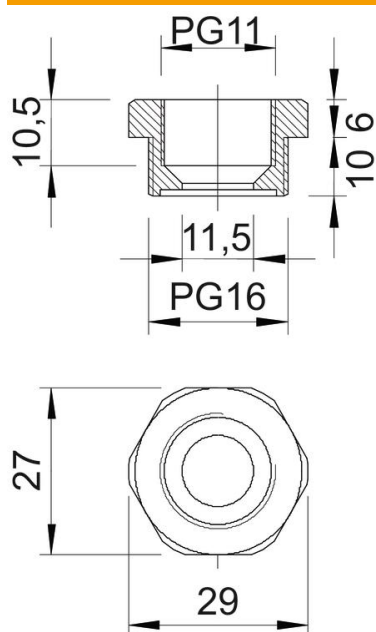

Dimension D	11,5 mm
Dimension E	29 mm
Dimension L1	10 mm
Dimension L2	6 mm
Dimension L3	10,5 mm

Tehnički podaci

zaštićeno od eksplozije	ne
Vrsta navoja spoljni navoj	PG
Vrsta navoja unutrašnji navoj	PG
Dužina navoja	10 mm
Dimenzije navoja PG spolja	16
Dimenzije navoja PG unutra	11
bez halogena	da
širina ključa	27
Niklovano	ne