

Technical data sheet

Dust protection plate, PG

Item number: 2028980



Cellular polyethylene.

Small protective disc to protect the V-TEC and V-TEC MS cable glands against dust before the cable is installed.

Application: the discs are pre-mounted between the cap nut and the seal. They do not need to be removed when the cable is installed, but are simply passed through to the interior with the cable.

Note: the discs do not provide any mechanical protection.



**ZELL
PC** Zell - Polyethylen

Master data

Item number	2028980
Type	107 S VTEC PG42
Description 1	Dust protection plate
Description 2	for penetration
Manufacturer	OBO
Dimension	PG42
Colour	Black
Material	Zell - Polyethylen
Smallest sales unit	100
Unit of quantity	Piece
Weight	0.05 kg
Weight unit	kg/100 pc.

Dimensions

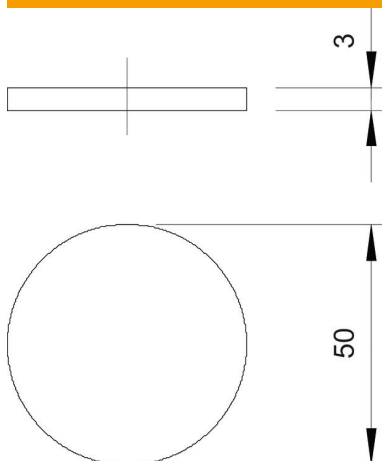

Dimension D	50 mm
Dimension t	3 mm

Technical data sheet

Dust protection plate, PG

Item number: 2028980



Technical data

Version for	Miscellaneous
Size	Pg 42
Impact-resistant	no