

Technical data sheet

Locknut, metric thread, silver grey

Item number: 2048795



Locknut to DIN 46319, with metric thread IEC 423.

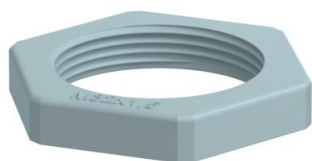

PA Polyamide

Master data

Item number	2048795
Type	116 M32 SGR PA
Description 1	Locknut
Manufacturer	OBO
Dimension	M32
Colour	Silver grey; RAL 7001
Material	Polyamide
Smallest sales unit	50
Unit of quantity	Piece
Weight	0.503 kg
Weight unit	kg/100 pc.

Technical data sheet

Locknut, metric thread, silver grey

Item number: 2048795



Dimensions



Dimension E	46 mm
Dimension L	7 mm

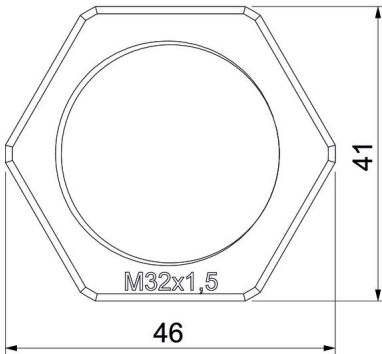

Technical data

Thread	M32_x_1,5
Thread type	Metric
Nominal thread size metric/PG	32
Fibre-glass reinforced	no
Halogen-free	yes
Impact-resistant	no
WAF	41