

# Technical data sheet

## Locknut, PG thread

Item number: 2043114



Locknut DIN 46320, with PG thread DIN 40430.

Note: Only tighten polystyrene cable glands lightly due to the risk of stress crack formation.



**PS** Polystyrene

### Master data

Item number	2043114
Type	116 PG11
Description 1	Locknut
Manufacturer	OBO
Dimension	PG11
Colour	Light grey; RAL 7035
Material	Polystyrene
Smallest sales unit	100
Unit of quantity	Piece
Weight	0.113 kg
Weight unit	kg/100 pc.

# Technical data sheet

Locknut, PG thread

Item number: 2043114



## Dimensions



Dimension E	26 mm
Dimension L	5 mm

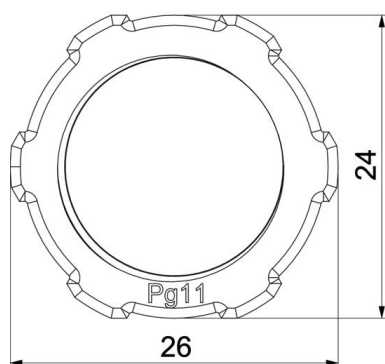

## Technical data

Thread	Pg_11
Thread type	PG
Nominal thread size metric/PG	11
Fibre-glass reinforced	no
Halogen-free	yes
Impact-resistant	yes
WAF	24