

Technical data sheet

Pipe end cap, splittable, PG, light grey

Item number: 2044509



Separable pipe end cap to slot onto PG electrical installation pipes.

The separable pipe end cap can be used for repairs on existing installations according to regulations. It is not necessary to disconnect the cables, allowing quick mounting.



PE Polyethylene

Master data

Item number	2044509
Type	129 TB PG9
Description 1	Pipe end sleeve, separable
Description 2	PG
Manufacturer	OBO
Dimension	PG9
Colour	Light grey; RAL 7035
Material	Polyethylene
Smallest sales unit	50
Unit of quantity	Piece
Weight	0.4 kg
Weight unit	kg/100 pc.

Technical data sheet

Pipe end cap, splittable, PG, light grey

Item number: 2044509



Dimensions

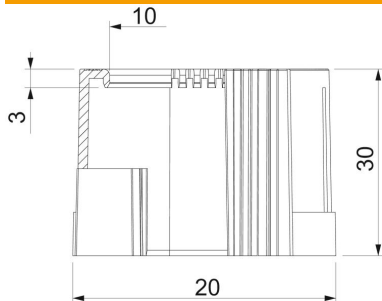

Dimension D1	20 mm
Dimension D2	10 mm
Dimension L1	30 mm
Dimension L2	3 mm

Technical data

Version for for pipe diameter	Connector 15.2 mm
Size	PG9
Brushed surface	no
Polished surface	no