

Technical data sheet

ISO nail clip 2009, black

Item number: 2232219



ISO nail clip, short design



PP

Polypropylene

Master data

Item number	2232219
Type	2009 25 SW
Description 1	ISO nail clip
Manufacturer	OBO
Dimension	9mm, L25
Colour	Jet black; RAL 9005
Material	Polypropylene
Smallest sales unit	100
Unit of quantity	Piece
Weight	0.109 kg
Weight unit	kg/100 pc.

Technical data sheet

ISO nail clip 2009, black

Item number: 2232219



Dimensions

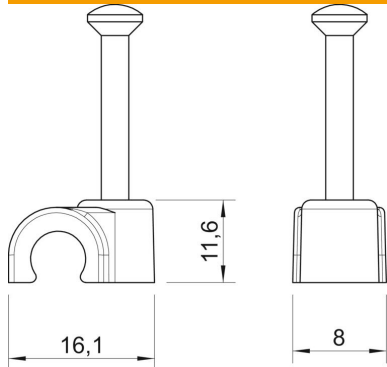

Dimension B	8 mm
Dimension H	11.6 mm
Dimension L	16.1 mm

Technical data

Double clip	no
Shape for cable diameter	Round (for round conductor)
For nail diameter	2,0x25
Hardened	yes
Halogen-free	yes
With nail	yes
Nail length	25 mm
Impact-resistant	no
Transparent	no
Pipe locking	no