

Technical data sheet

Lightning ISO clip, screw-on

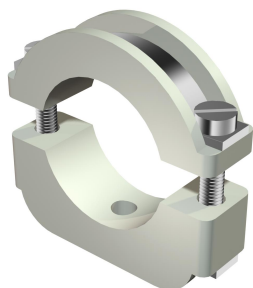

Item number: 2158175



Lightning ISO clips: plastic clip with metal insert, therefore also suitable for heavy-duty applications; metal parts made of electrogalvanised steel.
Can be screwed onto M6 thread.
*Sizes 6–12 and 10–17 not suitable for bolt-firing device.



PS Polystyrene

Master data

Item number	2158175
Type	3020 LGR
Description 1	Lightning ISO clip
Manufacturer	OBO
Dimension	10-17mm
Colour	Light grey; RAL 7035
Material	Polystyrene
Smallest sales unit	50
Unit of quantity	Piece
Weight	1.588 kg
Weight unit	kg/100 pc.

Technical data sheet

Lightning ISO clip, screw-on

Item number: 2158175

Dimensions

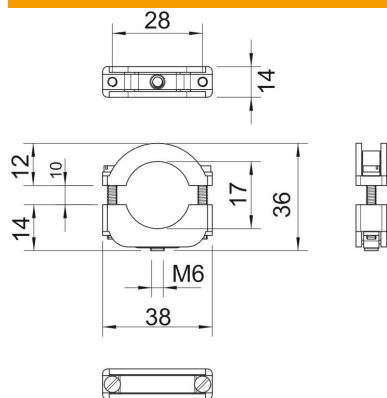

Dimension A	38 mm
Dimension B	28 mm
Dimension b	14 mm
Dimension D	17 mm
Dimension H	36 mm
Dimension Ho (mm)	12
Dimension Hu (mm)	14
Dimension l	25 mm
Dimension x	7 mm

Technical data

Number of cables/pipes	1
Version for	Closed
Fastening type	Threaded connection
Suitable in fire protection area	no
Halogen-free	yes
Plastic-covered	no
Bolt	M4 x 25
Clamping range D, max.	17 mm
Clamping range D, min.	10 mm
UV-resistant	no