

Technical data sheet

Cable and pipe spacer clip 732 with threaded connection V4A

Item number: 1360658



Mounting with screw-in spacer clips. Spacer clips and screw-in spacer clips are available in various materials: in V2A stainless steel, in electrogalvanised, hot-dip galvanised steel or in aluminium. Fastening can be take place with bolt ties or Angler anchors and Sprint screws. Depending on the design, the clips can be "shot" using a bolt-firing tool or nail device.



A4 Stainless steel

2B Bright, treated

Master data

Item number	1360658
Type	732 18 A4
Description 1	Distance saddle
Description 2	with threaded connection M6
Manufacturer	OBO
Dimension	16,5-18mm
Material	Stainless steel
Surface	Bright, treated
Surface standard	
Smallest sales unit	100
Unit of quantity	Piece
Weight	1.889 kg
Weight unit	kg/100 pc.

Technical data sheet

Cable and pipe spacer clip 732 with threaded connection V4A

Item number: 1360658



Dimensions

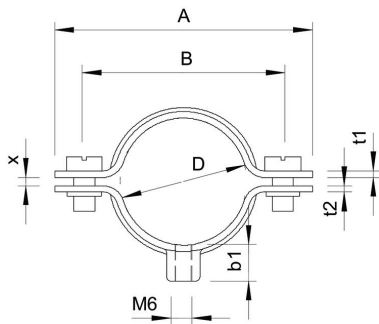

Length	44 mm
Dimension A	44 mm
Dimension B	32 mm
Dimension b1	9.8 mm
Dimension t1 (mm)	1
Dimension t2 (mm)	1.25
Dimension x	1.5 mm

Technical data

Distance to the wall	yes
Number of cables/pipes	1
Version for	Closed
Fastening type	Threaded connection
Suitable in fire protection area	yes
Size	PG11
Halogen-free	yes
Plastic-covered	no
Hole size	M6 mm
Material thickness	1 mm
Bolt	M5 x 12
Clamping range D, max.	18 mm
Clamping range D, min.	16.5 mm
UV-resistant	yes