

Technical data sheet

Cable and pipe spacer clip 732 with threaded connection V4A

Item number: 1360676



Mounting with screw-in spacer clips. Spacer clips and screw-in spacer clips are available in various materials: in V2A stainless steel, in electrogalvanised, hot-dip galvanised steel or in aluminium. Fastening can be take place with bolt ties or Angler anchors and Sprint screws. Depending on the design, the clips can be "shot" using a bolt-firing tool or nail device.



A4 Stainless steel

2B Bright, treated

Master data

Item number	1360676
Type	732 38 A4
Description 1	Distance saddle
Description 2	with threaded connection M6
Manufacturer	OBO
Dimension	36-38mm
Material	Stainless steel
Surface	Bright, treated
Surface standard	
Smallest sales unit	25
Unit of quantity	Piece
Weight	3.453 kg
Weight unit	kg/100 pc.

Technical data sheet

Cable and pipe spacer clip 732 with threaded connection V4A

Item number: 1360676



Dimensions

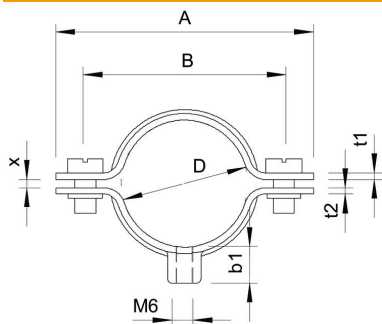

Length	69 mm
Dimension A	69 mm
Dimension B	55 mm
Dimension b1	10 mm
Dimension t1 (mm)	1.5
Dimension t2 (mm)	1.5
Dimension x	2 mm

Technical data

Distance to the wall	yes
Number of cables/pipes	1
Version for	Closed
Fastening type	Threaded connection
Suitable in fire protection area	yes
Size	PG29
Halogen-free	yes
Plastic-covered	no
Hole size	M6 mm
Material thickness	1.5 mm
Bolt	M5 x 12
Clamping range D, max.	38 mm
Clamping range D, min.	36 mm
UV-resistant	yes