

# Technical data sheet

## Hammer-head bolt A4

Item number: 1148084



Hammer-head bolt for use with CM3015, CM3518 and AM3518 profile rails



**A4** Stainless steel

**2B** Bright, treated

### Master data

Item number	1148084
Type	ACMHB M8x60 A4
Description 1	Hammerhead screw
Description 2	for profile rails, medium
Manufacturer	OBO
Dimension	M8x60mm
Material	Stainless steel
Surface	Bright, treated
Surface standard	
Smallest sales unit	25
Unit of quantity	Piece
Weight	4.65 kg
Weight unit	kg/100 pc.

# Technical data sheet

## Hammer-head bolt A4

Item number: 1148084



### Dimensions

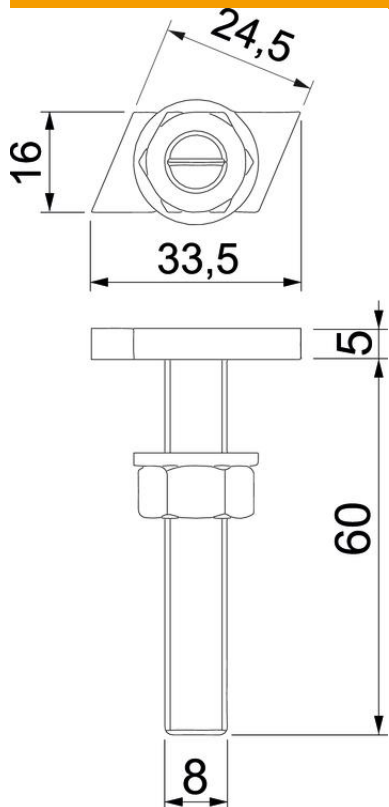

Length	33.5 mm
Width	16 mm
Height	5 mm
Dimension L	60 mm

### Technical data

Suitable for mounting rail	yes
Thread	M 8 x 60mm
Thread metric	8