

Technical data sheet

Suspension clamp, tunnel 320

Item number: 6364013



Suspension clamp to suspend cable trays, mesh cable trays and cable ladders specifically for tunnel construction. Tested to DIN 4102-12.



A5 Stainless steel

Master data

Item number	6364013
Type	AHB-T1732 VA4529
Description 1	Suspension bracket
Description 2	for tunnel construction
Available from	01.03.2023
Manufacturer	OBO
Dimension	170x320
Material	Stainless steel
Smallest sales unit	1
Unit of quantity	Piece
Weight	39.93 kg
Weight unit	kg/100 pc.

Technical data sheet

Suspension clamp, tunnel 320

Item number: 6364013



Dimensions

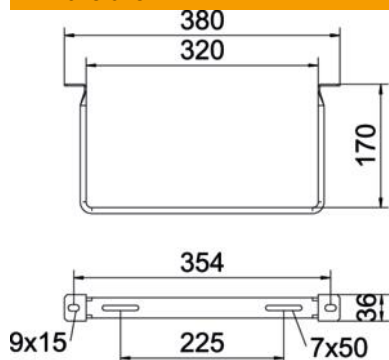

Dimension B	320 mm
Dimension b	225 mm
Dimension D	50 mm
Dimension H	170 mm
Dimension L	380 mm
Dimension l	354 mm

Technical data

Version for	Miscellaneous
Maintain electrical functions	yes
Suitable for mesh cable tray	yes
Suitable for cable ladder	yes
Suitable for cable tray	yes
Suitable for tray/ladder width	300 mm
Material thickness	2 mm
Tray fastening	Screw-on
Adjustable	no