

Technical data sheet

Spacer clip 733 A4

Item number: 1362926



Spacer clip for the installation of pipes and cables on walls, ceilings and floors. With self-locking cover. Fastening via slot.

Approved for the maintenance of electrical function according to DIN 4102 Part 12, maintenance of electrical function classes E 30 to E 90.



A4 Stainless steel

Master data

Item number	1362926
Type	ASL 733 36 A4
Description 1	Distance saddle
Description 2	with slot
Manufacturer	OBO
Dimension	30-36mm
Material	Stainless steel
Smallest sales unit	20
Unit of quantity	Piece
Weight	3.846 kg
Weight unit	kg/100 pc.

Technical data sheet

Spacer clip 733 A4

Item number: 1362926



Dimensions

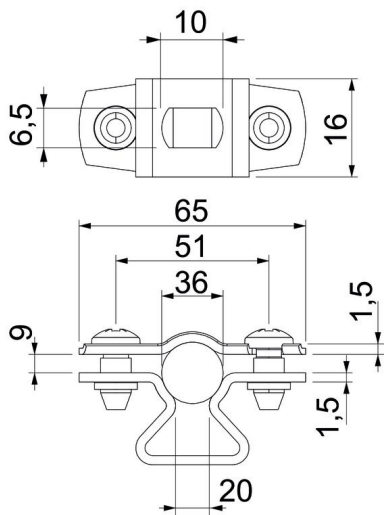

Dimension A	65 mm
Dimension B	51 mm
Dimension b	16 mm
Dimension D	36 mm
Dimension d max.	36 mm
Dimension d min.	30 mm
Dimension L	10 mm
Dimension s	20 mm
Dimension t1 (mm)	1.5
Dimension t2 (mm)	1.5
Dimension x	9 mm

Technical data

Distance to the wall	yes
Number of cables/pipes	1
Version for	Closed
Fastening type	Screw hole
For diameter	30 - 36
Suitable in fire protection area	yes
Halogen-free	yes
Plastic-covered	no
Material thickness	1.5 mm
Clamping range D, max.	36 mm
Clamping range D, min.	30 mm
UV-resistant	yes