

Technical data sheet

Wall and support bracket AW 55 A4

Item number: 6418601



Heavy-duty wall and support bracket with welded head plate.
Fastening of the bracket to the U support of width 400 mm or greater using a hexagonal bolt through both sides of the support. Please insert suitable spacers.



A4 Stainless steel

2B Bright, treated

Master data

Item number	6418601
Type	AW 55 41 A4
Description 1	Wall and support bracket
Description 2	with welded head plate
Manufacturer	OBO
Dimension	B410mm
Material	Stainless steel
Surface	Bright, treated
Surface standard	
Smallest sales unit	1
Unit of quantity	Piece
Weight	162.8 kg
Weight unit	kg/100 pc.

Technical data sheet

Wall and support bracket AW 55 A4

Item number: 6418601



Dimensions

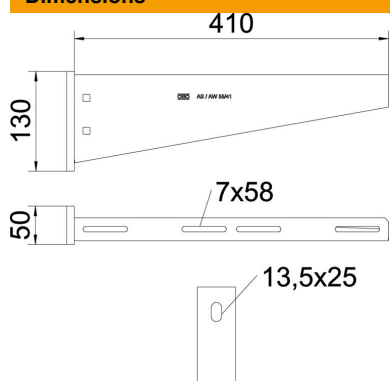

Length	50 mm
Width	410 mm
Height	130 mm
Dimension A	50 mm
Dimension B	410 mm
Dimension H	130 mm

Technical data

Version for	Wall and support bracket
F in kN	5.5 kN
Maintain electrical functions	no
Hole diameter	13.5 mm
Rustproof steel, pickled	yes
Angle range, max.	90 mm
Angle range, min.	90 mm

Loads

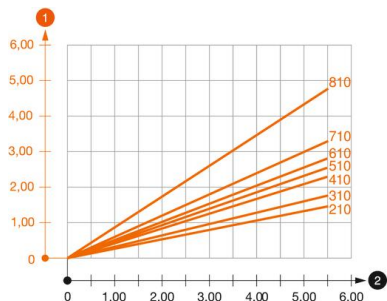

Load diagram, bracket, type AW 55

- 1 Bending of the bracket tip at permitted bracket load
- 2 Permitted bracket load in kN without man load
- Load curve with bracket lengths in mm

Characteristic anchor load values for wall and support bracket AW 55

Anchor type	Wall fastening									
	Max. load [kN]									
	Bracket width [mm]									
	210	310	410	510	560	610	710	810	910	1010
BZ3 12x110/0-35	3.92	3.83	3.79	3.46	3.30	3.30	3.15	2.53	2.38	2.23

Die angegebenen Werte basieren auf ungerissenen Beton der Festigkeitsklasse C20/25. Die Einbaubedingungen der ETA-Zulassung (Dübel) sind zu beachten!