

# Technical data sheet

## Cover for 90° Magic bend DD

Item number: 7138540



Cover for 90° bend with pre-mounted turn buckles.  
The cover can be used with fittings of all side heights.

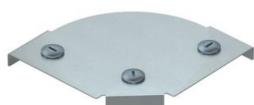

**St** Steel

**DD** Strip galvanised zinc/aluminium, Double Dip

### Master data

Item number	7138540
Type	DFBM 90 100 DD
Description 1	90° bend cover
Description 2	for bend RBM 90 100
Manufacturer	OBO
Dimension	B=100mm
Material	Steel
Surface	Strip galvanised zinc/aluminium, Double Dip
Surface standard	DIN EN 10346
Smallest sales unit	1
Unit of quantity	Piece
Weight	17.1 kg
Weight unit	kg/100 pc.

# Technical data sheet

## Cover for 90° Magic bend DD

Item number: 7138540



### Dimensions

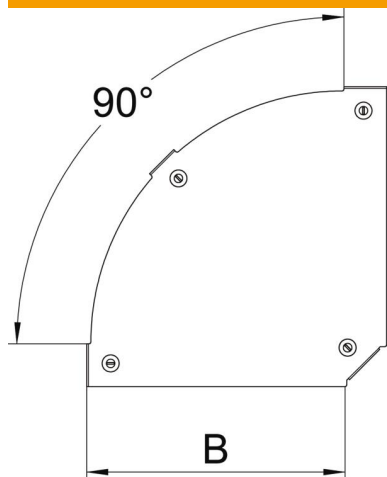

Width	100 mm
Width	4 in
Plate thickness	0.05 in
Plate thickness	1.25 mm
Dimension B	100 mm

### Technical data

Bend (angle)	90°
Fastening type	Sash lock
Maintain electrical functions	no
Suitable for mesh cable tray	no
Suitable for cable ladder	no
Suitable for cable tray	yes
Change of direction	Horizontal
Rustproof steel, pickled	no
Hinged	no