

# Technical data sheet

## Centre suspension mesh cable tray A4

Item number: 6015418



Centre suspension including hold-down clamp for mesh cable tray suspensions.



**A4** Stainless steel

**2B** Bright, treated

### Master data

Item number	6015418
Type	GMS 170 A4
Description 1	Centre suspension
Description 2	for mesh cable tray with clamp
Manufacturer	OBO
Dimension	B170mm
Material	Stainless steel
Surface	Bright, treated
Surface standard	
Smallest sales unit	25
Unit of quantity	Piece
Weight	20 kg
Weight unit	kg/100 pc.

# Technical data sheet

## Centre suspension mesh cable tray A4

Item number: 6015418



### Dimensions

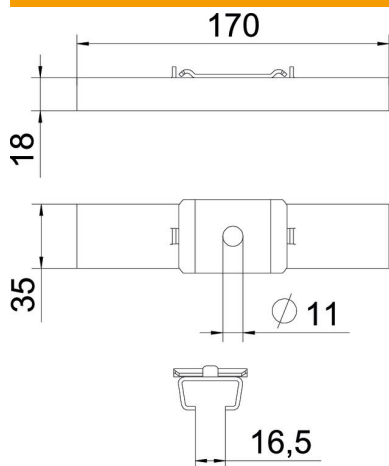

Length	35 mm
Width	170 mm
Height	18 mm
Dimension B	170 mm

### Technical data

Version for	Suspended
Maintain electrical functions	no
for width max.	170 mm
for width min.	170
Suitable for metric threaded rod	10
Hole diameter	11 mm
Adjustable	no