

Technical data sheet

90° mesh cable tray bend G

Item number: 6002384



90° bend, horizontal, for all mesh cable trays of 105 mm side height.

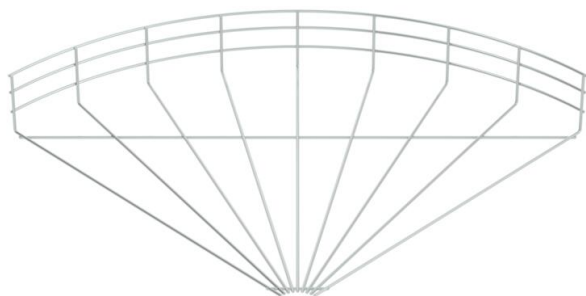

St Steel

G Electrogalvanized

Master data

Item number	6002384
Type	GRB 90 160 G
Description 1	90° mesh cable tray bend
Manufacturer	OBO
Dimension	105x600
Material	Steel
Surface	Electrogalvanized
Surface standard	EN ISO 19598 / EN ISO 4042
Smallest sales unit	1
Unit of quantity	Piece
Weight	132.7 kg
Weight unit	kg/100 pc.

Technical data sheet

90° mesh cable tray bend G

Item number: 6002384



Dimensions

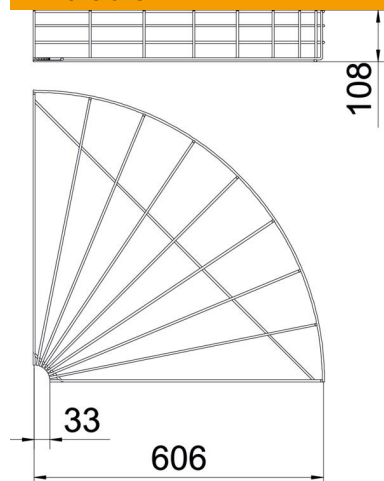

Width	600 mm
Width	23.62 in
Height	105 mm
Dimension A	33 mm
Dimension B	606 mm
Dimension H	108 mm

Technical data

Bend (angle)	90°
Connector version	Without connectors
Type	Horizontal bend
Maintain electrical functions	no
Rustproof steel, pickled	no