

Technical data sheet

Drop-out plate FT

Item number: 6220436



Exit plate for installation on the rung for vertically exiting cables.
Including appropriate screws and nut-and-washer assemblies.

CE

St	Steel
FT	Hot-dip galvanised

Master data

Item number	6220436
Type	LAB 20 FT
Description 1	Outgoing plate
Description 2	for cable ladder
Manufacturer	OBO
Dimension	B200mm
Material	Steel
Surface	Hot-dip galvanised
Surface standard	DIN EN ISO 1461
Smallest sales unit	1
Unit of quantity	Piece
Weight	37 kg
Weight unit	kg/100 pc.

Dimensions

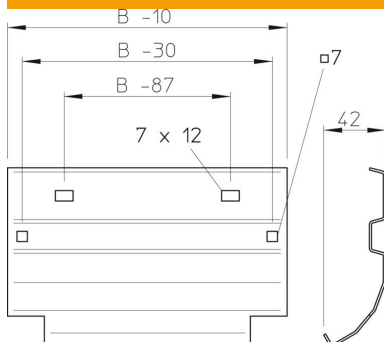

Width	200 mm
Height	45 mm
Plate thickness	1.5 mm
Dimension B	200 mm

Technical data sheet

Drop-out plate FT

Item number: 6220436



Technical data

Maintain electrical functions	yes
Rustproof steel, pickled	no
Wide-span version	no