

Technical data sheet

Drop-out plate FT

Item number: 6220444



Exit plate for installation on the rung for vertically exiting cables.
Including appropriate screws and nut-and-washer assemblies.



St Steel

FT Hot-dip galvanised

Master data

Item number	6220444
Type	LAB 30 FT
Description 1	Outgoing plate
Description 2	for cable ladder
Manufacturer	OBO
Dimension	B300mm
Material	Steel
Surface	Hot-dip galvanised
Surface standard	DIN EN ISO 1461
Smallest sales unit	1
Unit of quantity	Piece
Weight	58 kg
Weight unit	kg/100 pc.

Dimensions

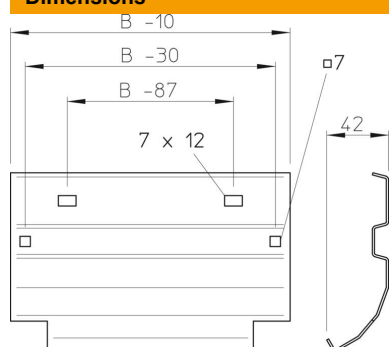

Width	300 mm
Height	45 mm
Plate thickness	1.5 mm
Dimension B	300 mm

Technical data sheet

Drop-out plate FT

Item number: 6220444



Technical data

Maintain electrical functions	yes
Rustproof steel, pickled	no
Wide-span version	no