

Technical data sheet

Adjustable bend element 60 FS

Item number: 6225450



Adjustable bend element with welded rung for use in the cable ladder types with a side height of 60 mm.

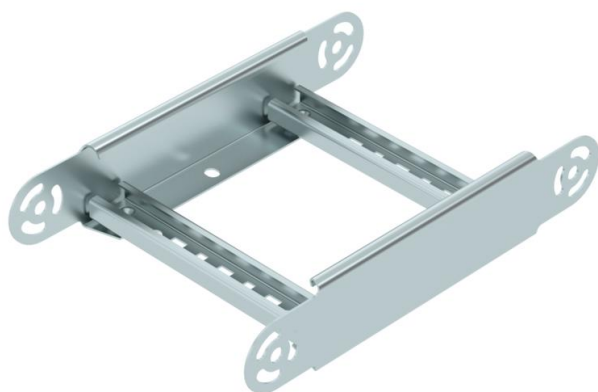

St Steel

FS Strip galvanized

Master data

Item number	6225450
Type	LGBE 620 FS
Description 1	Adjustable bend element
Description 2	for cable ladder
Manufacturer	OBO
Dimension	60x200
Material	Steel
Surface	Strip galvanized
Surface standard	DIN EN 10346
Smallest sales unit	1
Unit of quantity	Piece
Weight	84 kg
Weight unit	kg/100 pc.

Technical data sheet

Adjustable bend element 60 FS

Item number: 6225450



Dimensions

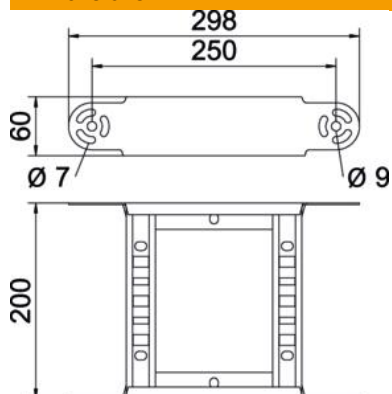

Width	200 mm
Height	60 mm
Dimension B	200 mm
Dimension R	200 mm

Technical data

Bend (angle)	Adjustable
Version of the rungs	Profile perforated
Side rail version	Flat profile
Connector version	Integrated connector
Maintain electrical functions	no
Change of direction	Vertical, rising/falling
Rustproof steel, pickled	no
Hinged	no
Side perforation	no
Wide-span version	no
Rail thickness	1.5 mm