

# Technical data sheet

## Cable ladder LG 60, 6 m VS A2

Item number: 6208709



Cable ladder with perforated side rail of side height 60 mm with riveted C profile frames, open in an upwards direction (VS version).  
The cable ladder is shipped folded up.

You can find the appropriate type 2056 clamp clip in the vertical ladder systems section.  
Magnetic shield insulation without cover 10 dB, with cover 15 dB.



**A2** Stainless steel

**2B** Bright, treated

### Master data

Item number	6208709
Type	LG 650 VS6 A2
Description 1	Cable ladder
Description 2	perforated, with VS rung
Manufacturer	OBO
Dimension	60x500x6000
Material	Stainless steel
Surface	Bright, treated
Surface standard	
Smallest sales unit	6
Unit of quantity	Metre
Weight	332.4 kg
Weight unit	kg/100 m

# Technical data sheet

## Cable ladder LG 60, 6 m VS A2

Item number: 6208709



### Dimensions

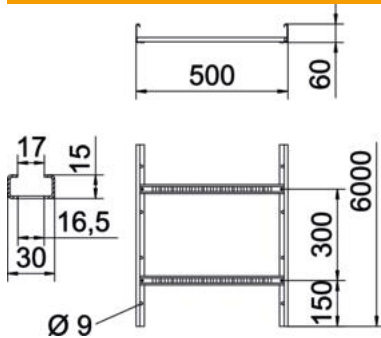

Dimension	60x500x6000
Length	6,000 mm
Length	6,000 ft
Width	500 mm
Height	60 mm
Dimension B	500 mm
Rung slot dimension	16.50

### Technical data

Version of the rungs	Profile perforated
Side rail version	Flat profile
Fastening of rung	Blind riveted
Maintain electrical functions	no
Usable cross-section	248 cm <sup>2</sup>
Usable cross-section	24800 mm <sup>2</sup>
Rustproof steel, pickled	no
Side perforation	yes
Rung distance	300 mm
Wide-span version	no
Rail thickness	1.5 mm

### Loads

Insertable support spacings, min.	1.5 m
Insertable support spacings, max.	4 m
Support spacing 1.5 m	3.1 kN/m
Support spacing 2.0 m	2.25 kN/m
Support spacing 2.5 m	1.5 kN/m
Support spacing 3.0 m	1.1 kN/m
Support spacing 3.5 m	0.75 kN/m
Support spacing 4.0 m	0.45 kN/m

### Load diagram, cable ladder, type LG 60 VS

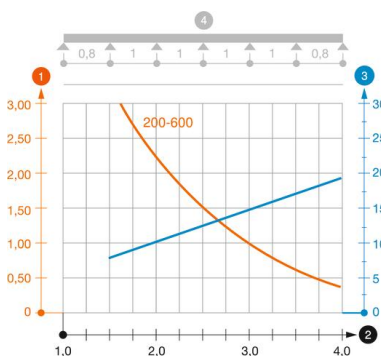

- 1 Permitted cable tray/ladder load in kN/m without man load
- 2 Support width in m
- 3 Rail bend in mm at permitted kN/m
- 4 Load scheme during testing
- Load curve with cable tray/ladder width in mm
- Strut bend curve according to support width