

Technical data sheet

Hammer-head bolt with spring A4

Item number: 1148492



Hammer-head bolt with spring for use with MS4121 and MS4141 profile rails

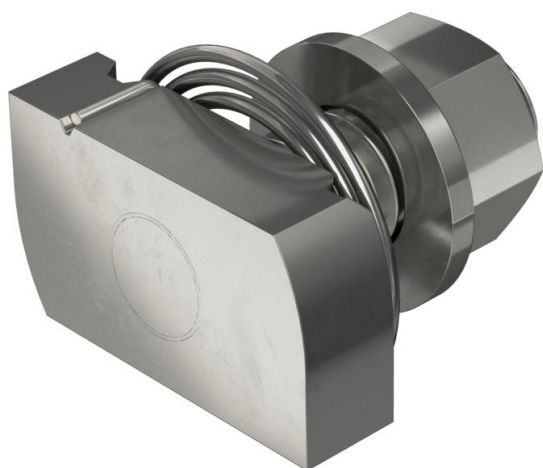

A4 Stainless steel

2B Bright, treated

Master data

Item number	1148492
Type	MS41HBF M12x30A4
Description 1	Hammerhead screw with spring
Description 2	for profile rail MS4121/4141
Manufacturer	OBO
Dimension	M12x30mm
Material	Stainless steel
Surface	Bright, treated
Surface standard	
Smallest sales unit	50
Unit of quantity	Piece
Weight	9.7 kg
Weight unit	kg/100 pc.

Technical data sheet

Hammer-head bolt with spring A4

Item number: 1148492



Dimensions

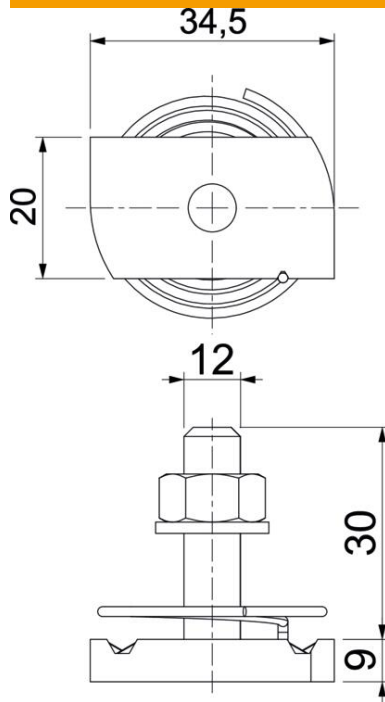

Length	34.5 mm
Width	20 mm
Height	9 mm
Dimension H	9 mm
Dimension L	30 mm

Technical data

Torque	14.4 Nm
Suitable for mounting rail	yes
Thread	M 12 x 30
Washer Ø	24 mm