

# Technical data sheet

## Hammer-head bolt with spring A4

Item number: 1148476



Hammer-head bolt with spring for use with MS4121 and MS4141 profile rails



**A4** Stainless steel

**2B** Bright, treated

### Master data

Item number	1148476
Type	MS41HBF M8x30 A4
Description 1	Hammerhead screw with spring
Description 2	for profile rail MS4121/4141
Manufacturer	OBO
Dimension	M8x30mm
Material	Stainless steel
Surface	Bright, treated
Surface standard	
Smallest sales unit	50
Unit of quantity	Piece
Weight	4.8 kg
Weight unit	kg/100 pc.

# Technical data sheet

## Hammer-head bolt with spring A4

Item number: 1148476



### Dimensions

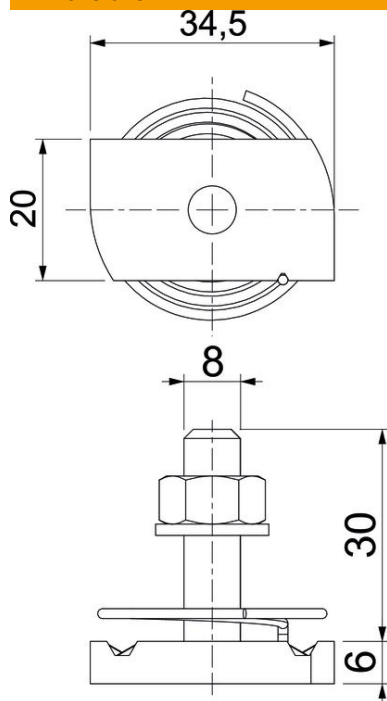

Length	34.5 mm
Width	20 mm
Height	6 mm
Dimension H	6 mm
Dimension L	30 mm

### Technical data

Torque	6.2 Nm
Suitable for mounting rail	yes
Thread	M 8 x 30
Washer Ø	16 mm