

Technical data sheet

Hammer-head bolt with spring A4

Item number: 1148480



Hammer-head bolt with spring for use with MS4121 and MS4141 profile rails



A4 Stainless steel

2B Bright, treated

Master data

Item number	1148480
Type	MS41HBF M8x60 A4
Description 1	Hammerhead screw with spring
Description 2	for profile rail MS4121/4141
Manufacturer	OBO
Dimension	M8x60mm
Material	Stainless steel
Surface	Bright, treated
Surface standard	
Smallest sales unit	25
Unit of quantity	Piece
Weight	5.95 kg
Weight unit	kg/100 pc.

Technical data sheet

Hammer-head bolt with spring A4

Item number: 1148480



Dimensions

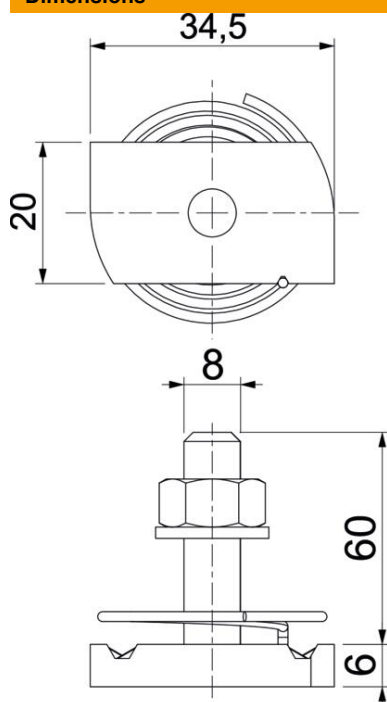

Length	34.5 mm
Width	20 mm
Height	6 mm
Dimension H	6 mm
Dimension L	60 mm

Technical data

Torque	6.2 Nm
Suitable for mounting rail	yes
Thread	M 8 x 60
Washer Ø	16 mm