

# Technical data sheet

## Hammer-head bolt with spring FT

Item number: 1148380



Hammer-head bolt with spring for use with MS4121 and MS4141 profile rails



**St** Steel

**FT** Hot-dip galvanised

### Master data

Item number	1148380
Type	MS41HBF M8x60 FT
Description 1	Hammerhead screw with spring
Description 2	for profile rail MS4121/4141
Manufacturer	OBO
Dimension	M8x60mm
Material	Steel
Surface	Hot-dip galvanised
Surface standard	DIN EN ISO 1461
Smallest sales unit	25
Unit of quantity	Piece
Weight	6.3 kg
Weight unit	kg/100 pc.

# Technical data sheet

## Hammer-head bolt with spring FT

Item number: 1148380



### Dimensions

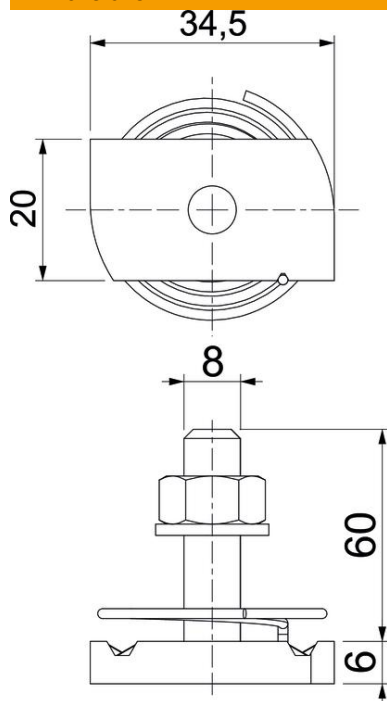

Length	34.5 mm
Width	20 mm
Height	6 mm
Dimension H	6 mm
Dimension L	60 mm

### Technical data

Torque	8 Nm
Suitable for mounting rail	yes
Thread	M 8 x 60
Washer Ø	16 mm