

# Technical data sheet

## Hammer-head bolt A4

Item number: 1148430



Hammer-head bolt for use with MS4121 and MS4141 profile rails



**A4** Stainless steel

**2B** Bright, treated

### Master data

Item number	1148430
Type	MS41HB M10x100A4
Description 1	Hammerhead screw
Description 2	for profile rail MS4121/4141
Manufacturer	OBO
Dimension	M10x100mm
Material	Stainless steel
Surface	Bright, treated
Surface standard	
Smallest sales unit	20
Unit of quantity	Piece
Weight	11.65 kg
Weight unit	kg/100 pc.

# Technical data sheet

## Hammer-head bolt A4

Item number: 1148430



### Dimensions

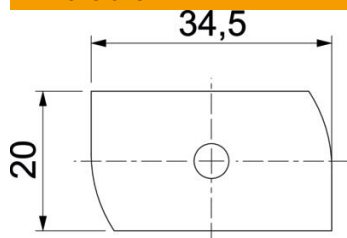

Length	34.5 mm
Width	20 mm
Height	8 mm
Dimension H	8 mm
Dimension L	100 mm

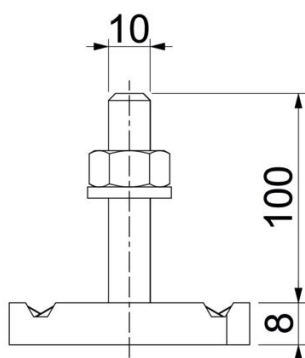

### Technical data

Torque	9.9 Nm
Suitable for mounting rail	yes
Thread	M 10 x 100
Washer Ø	20 mm