

Technical data sheet

Hammer-head bolt ZL

Item number: 1148330



Hammer-head bolt for use with MS4121 and MS4141 profile rails

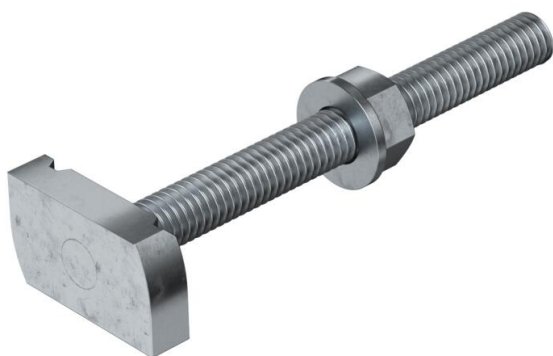

St Steel

ZL Zinc slat

Master data

Item number	1148330
Type	MS41HB M10x100ZL
Description 1	Hammerhead screw
Description 2	for profile rail MS4121/4141
Manufacturer	OBO
Dimension	M10x100mm
Material	Steel
Surface	Zinc slat
Surface standard	
Smallest sales unit	20
Unit of quantity	Piece
Weight	11.7 kg
Weight unit	kg/100 pc.

Technical data sheet

Hammer-head bolt ZL

Item number: 1148330



Dimensions

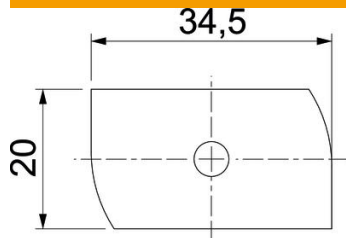

Length	34.5 mm
Width	20 mm
Height	8 mm
Dimension H	8 mm
Dimension L	100 mm

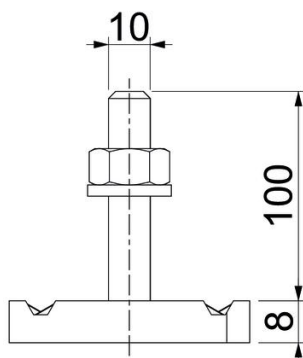

Technical data

Torque	16 Nm
Suitable for mounting rail	yes
Thread	M 10 x 100
Washer Ø	20 mm