

Technical data sheet

Hammer-head bolt A4

Item number: 1148442



Hammer-head bolt for use with MS4121 and MS4141 profile rails

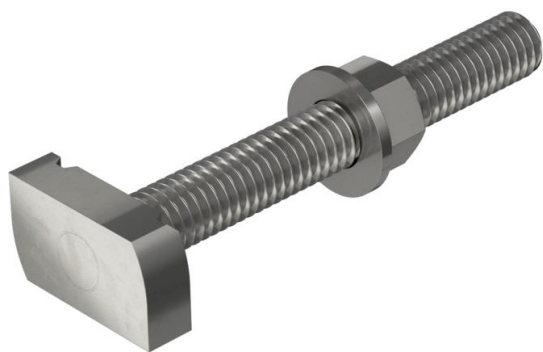

A4 Stainless steel

2B Bright, treated

Master data

Item number	1148442
Type	MS41HB M12x100A4
Description 1	Hammerhead screw
Description 2	for profile rail MS4121/4141
Manufacturer	OBO
Dimension	M12x100mm
Material	Stainless steel
Surface	Bright, treated
Surface standard	
Smallest sales unit	20
Unit of quantity	Piece
Weight	15.9 kg
Weight unit	kg/100 pc.

Technical data sheet

Hammer-head bolt A4

Item number: 1148442



Dimensions

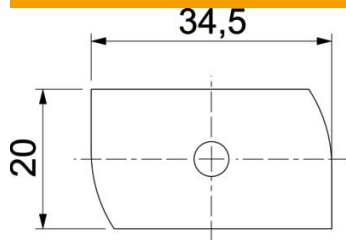

Length	34.5 mm
Width	20 mm
Height	9 mm
Dimension H	9 mm
Dimension L	100 mm

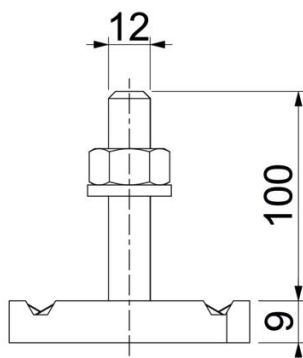

Technical data

Torque	14.4 Nm
Suitable for mounting rail	yes
Thread	M 12 x 100
Washer Ø	24 mm