

Technical data sheet

Internal corner, duct height 80 mm, FS

Item number: 7218054



Internal corner with intumescent fire protection mesh for PYROLINE® Rapid PLM installation duct. Suitable for direct wall and ceiling mounting, mounting below system floors and on support systems. Tool-free joint mounting with PLM SI joint connector. The cover is snapped on without tools, allowing rapid inspection and retroassignment. The cover overhang allows offset cover mounting for continuous equipotential bonding of the entire duct section.



St Steel

FS Strip galvanized

Master data

Item number	7218054
Type	PLM IC 0810 FS
Description 1	Internal corner
Description 2	with fire protection mesh
Manufacturer	OBO
Dimension	330x100x330
Material	Steel
Surface	Strip galvanized
Surface standard	DIN EN 10346
Smallest sales unit	1
Unit of quantity	Piece
Weight	156 kg
Weight unit	kg/100 pc.

Technical data sheet

Internal corner, duct height 80 mm, FS

Item number: 7218054



Dimensions

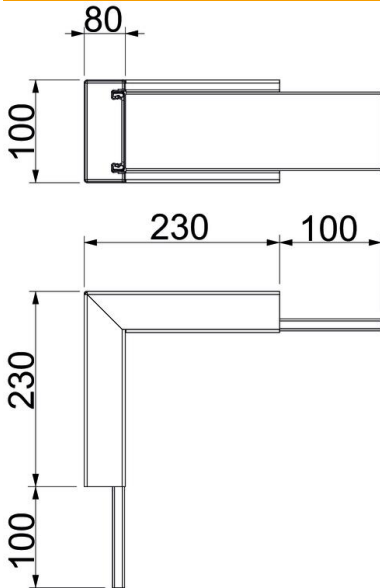

Dimension A	230 mm
Dimension B	100 mm
Dimension H	80 mm

Technical data

Number of flammable sides	4
Cover fastening	Miscellaneous
With perforation	yes
Usable cross-section	5180 mm ²
Partitions possible	no
Jacketing	Steel
Angle of the bend	90 °