

Technical data sheet

90° Magic bend 60 FS

Item number: 6041136



90° bend with quick connector system. For all cable tray types of 60 mm side height.

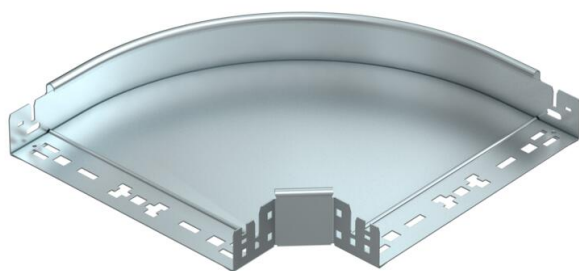

St Steel

FS Strip galvanized

Master data

Item number	6041136
Description 1	90° bend
Description 2	with quick connector
Manufacturer	OBO
Dimension	60x300
Material	Steel
Surface	Strip galvanized
Surface standard	DIN EN 10346
Smallest sales unit	1
Unit of quantity	Piece
Weight	192.2 kg
Weight unit	kg/100 pc.

Technical data sheet

90° Magic bend 60 FS

Item number: 6041136



Dimensions

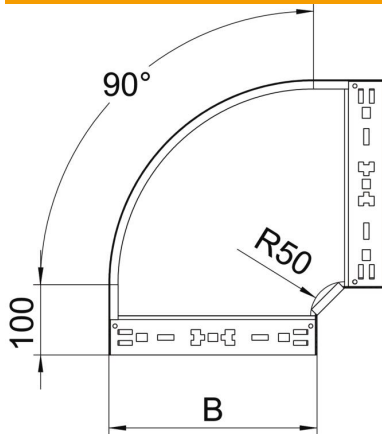

Width	300 mm
Width	12 in
Height	60 mm
Height	2 in
Plate thickness	1.25 mm
Dimension B	300 mm

Technical data

Bend (angle)	90°
Connector version	Integrated connector
Maintain electrical functions	yes
Mounting perforation in base	no
NATO hole pattern	no
Change of direction	Horizontal
Rustproof steel, pickled	no
Side perforation	no
Wide-span version	no
Type of connector, cable support system	Click fastening