

Technical data sheet

Heavy-duty frame cassette for tube body, RKFSL, nominal size 250-3

Item number: 7409524



Heavy-duty frame cassette for tube body for the installation of accessories in the UZD250-3 in dry or wet-care floors in interior areas Load class 2 to 20 kN. The tube body is not contained in the scope of delivery.

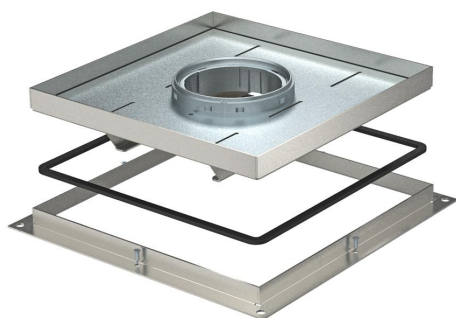

A2 Stainless steel

Master data

Item number	7409524
Description 1	Heavy-duty frame cassette
Description 2	for tube
Manufacturer	OBO
Dimension	283x283x25
Material	Stainless steel
Smallest sales unit	1
Unit of quantity	Piece
Weight	719 kg
Weight unit	kg/100 pc.

Technical data sheet

Heavy-duty frame cassette for tube body, RKFSL, nominal size 250-3

Item number: 7409524



Dimensions

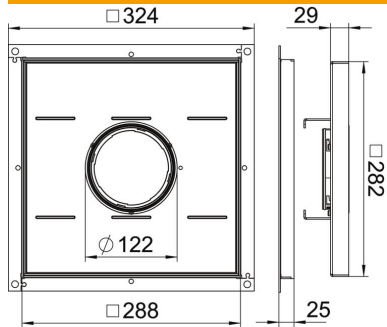

Dimension A	324 mm
Dimension B	288 mm
Dimension C	282 mm
Dimension h	25 mm

Technical data

Cable outlet version	Lowerable tube body
Suitable for raised floor installation	yes
Suitable for cavity floor installation	yes
Suitable for	Underfloor socket structure
Suitable for underfloor box	250
Length of installation dimensions	290 mm
Protection rating (IP) when used	IP20
Protection rating (IP) when unused	IP44
Protection rating IK code	IK10
Heavy-duty version	yes
Heavy load class	20 kN (OBO SL2)
Floor covering thickness	19 mm