

Technical data sheet

Reducer / stop-end 35 DD

Item number: 7107013



Reducer/stop-end for cable trays with side height 35 mm.
From a width of 150 mm, a perforated lower flange is available.

Including appropriate fastening material.

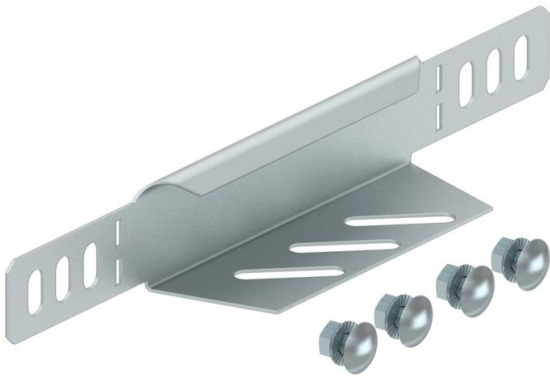

St Steel

DD Strip galvanised zinc/aluminium, Double Dip

Master data

Item number	7107013
Type	RWEB 310 DD
Description 1	Reducer profile/end closure
Description 2	for cable tray
Manufacturer	OBO
Dimension	35x100
Material	Steel
Surface	Strip galvanised zinc/aluminium, Double Dip
Surface standard	DIN EN 10346
Smallest sales unit	1
Unit of quantity	Piece
Weight	8.3 kg
Weight unit	kg/100 pc.

Technical data sheet

Reducer / stop-end 35 DD

Item number: 7107013



Dimensions

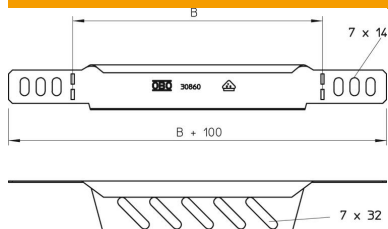

Width	100 mm
Height	35 mm
Plate thickness	1 mm
Dimension B	100 mm

Technical data

Maintain electrical functions	no
Rustproof steel, pickled	no