

Technical data sheet

Black powder-coated steel bend, without thread

Item number: 2046829



90° bend with moulded sleeves, for electrical installation pipes according to EN 61386-1. With burr-free inner wall.



St Steel

PE50 PES50 - Polyester/epoxy

Master data

Item number	2046829
Type	SBN50 SW
Description 1	Conduit plug-in bend
Description 2	without thread
Manufacturer	OBO
Dimension	Ø50mm
Colour	Jet black; RAL 9005
Material	Steel
Surface	PES50 - Polyester/epoxy
Surface standard	
Smallest sales unit	5
Unit of quantity	Piece
Weight	111.8kg
Weight unit	kg/100 pc.

Technical data sheet

Black powder-coated steel bend, without thread

Item number: 2046829



Dimensions

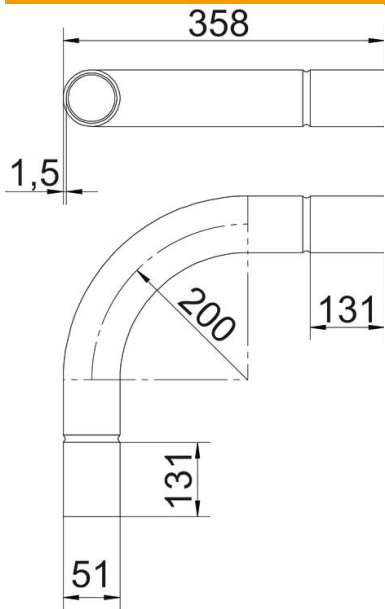

Dimension A	131 mm
Dimension B	358 mm
Dimension D	54 mm
Dimension d	51 mm
Dimension l	60 mm
Dimension m (mm)	M50
Dimension R	200 mm
Dimension t	1.5 mm

Technical data

Version for	Connector
Flexible	no
For nominal pipe diameter	50 mm
Halogen-free	no
With inspection opening and lid	no
With sleeve	yes
Brushed surface	no
Polished surface	no
Angle of the bend	90 °
Two-part	no