

Technical data sheet

Electrogalvanised steel bend, with thread

Item number: 2046778



90° bend for electrical installation pipes according to EN 61386-1 with threaded ends to DIN EN 60423. With burr-free inner wall.
One connection sleeve is already screwed onto each pipe bend.



St Steel

G Electrogalvanized

Master data

Item number	2046778
Type	SBNM16 G
Description 1	Conduit threaded bend
Description 2	with threaded coupler
Manufacturer	OBO
Dimension	M16x1,5
Material	Steel
Surface	Electrogalvanized
Surface standard	EN ISO 19598 / EN ISO 4042
Smallest sales unit	15
Unit of quantity	Piece
Weight	10.4 kg
Weight unit	kg/100 pc.

Technical data sheet

Electrogalvanised steel bend, with thread

Item number: 2046778



Dimensions

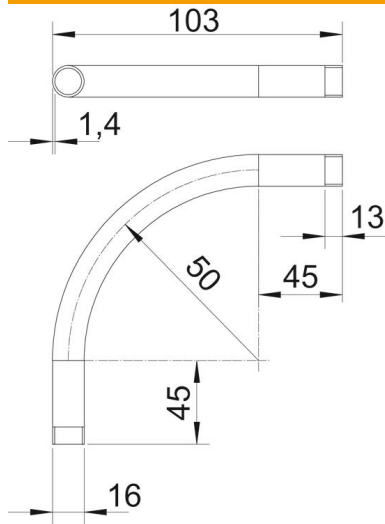

Dimension A	45 mm
Dimension B	103 mm
Dimension D	16 mm
Dimension l	13 mm
Dimension m (mm)	M16
Dimension R	50 mm
Dimension t	1.4 mm

Technical data

Version for	Thread
Flexible	no
For nominal pipe diameter	16 mm
Thread	M16x1,5
Halogen-free	no
With inspection opening and lid	no
With sleeve	yes
Brushed surface	no
Polished surface	no
Angle of the bend	90 °
Two-part	no