

Technical data sheet

TP support FT

Item number: 6364500



TP support for fastening to horizontal concrete ceilings.
If the profile is fastened directly to the ceiling or the profile is screwed together as head reinforcement, then, for reasons of stability, always use the spacer, type DS 4.

Important: only use brackets of length 345 mm or less.



St Steel

FT Hot-dip galvanised

Master data

Item number	6364500
Type	TPS 545 FT
Description 1	TP suspended support
Manufacturer	OBO
Dimension	L545mm
Material	Steel
Surface	Hot-dip galvanised
Surface standard	DIN EN ISO 1461
Smallest sales unit	1
Unit of quantity	Piece
Weight	89 kg
Weight unit	kg/100 pc.

Technical data sheet

TP support FT

Item number: 6364500



Dimensions

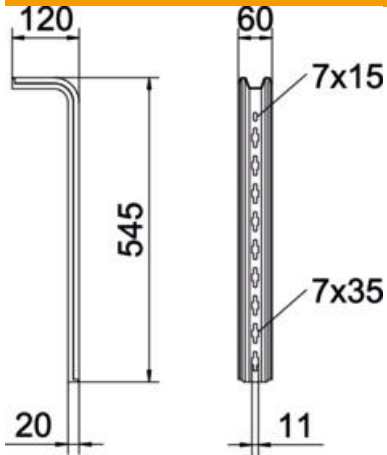

Length	545 mm
Width	60 mm
Height	120 mm
Dimension L	545 mm

Technical data

Version for	S profile
Maintain electrical functions	no

Loads

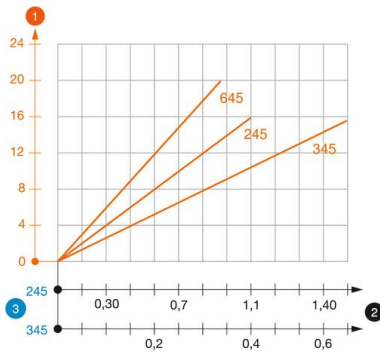

Load diagram, TP support, type TPS

- 1 Bending of the end of the suspended support at permitted bracket load
- 2 Permitted bracket load in kN without man load
- 3 Bracket length in mm
- Load curves with support lengths in mm

Characteristic anchor load values for TP support

Single-sided load

Anchor type	Max. load [kN]		
	Bracket width [mm]		
	145	245	345
BZ3 8x75/0-20	1.48	0.93	0.68
BZ3 10x90/0-30	1.48	0.93	0.68

Max. total load $F = \text{cable weight} + \text{cable tray} + \text{bracket} + \text{suspended support}$. The tabular values for double-sided loads take the available axis spacing $a_i = 17 \text{ cm}$ into account. The load capacity values increase considerably when used in uncracked concrete. The specified values are based on concrete of resistance class C20/25. Comply with the installation conditions of the DIBt approval (anchors).