

Technical data sheet

Sprung cover, 70 mm

Item number: 2003227

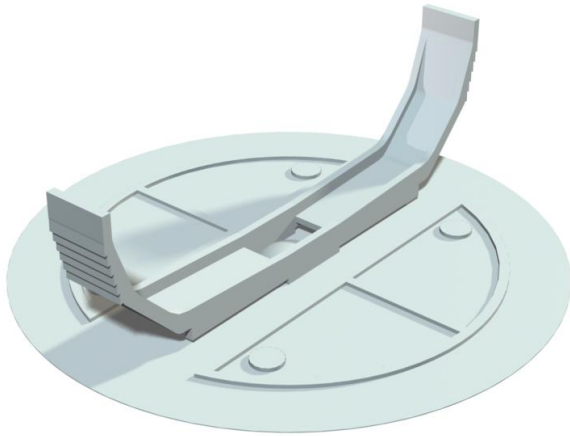

Sprung cover with centrally moulded, elastic spreading spring, for sockets with \varnothing 70 mm, cover edge is flush, surface is roughened.



PS Polystyrene

Master data

Item number	2003227
Type	UV 70 FD
Description 1	Sprung lid
Description 2	Concealed
Manufacturer	OBO
Dimension	\varnothing 84mm
Colour	White
Material	Polystyrene
Smallest sales unit	25
Unit of quantity	Piece
Weight	1.2 kg
Weight unit	kg/100 pc.

Dimensions

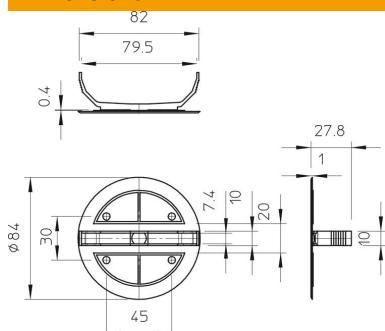

Height	1 mm
--------	------

Technical data sheet

Sprung cover, 70 mm

Item number: 2003227



Technical data

Fastening type	Spring cover
Flame-resistant	Acc. to VDE 0471/DIN 695 Part 2-1, test temperature 750°C
Shape	Round
Halogen-free	yes
With bolts	no
Sealable	no