

Technical data sheet

Large washer G

Item number: 3403122



Washer of particularly large outer diameter.

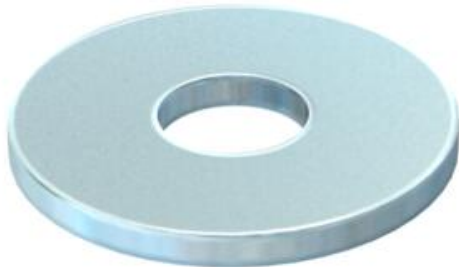

St Steel

G Electrogalvanized

Master data

Item number	3403122
Type	WS M8 G20 G
Description 1	Fender plate
Manufacturer	OBO
Dimension	M8,Ø20mm
Material	Steel
Surface	Electrogalvanized
Surface standard	EN ISO 19598 / EN ISO 4042
Smallest sales unit	100
Unit of quantity	Piece
Weight	0.227 kg
Weight unit	kg/100 pc.

Dimensions

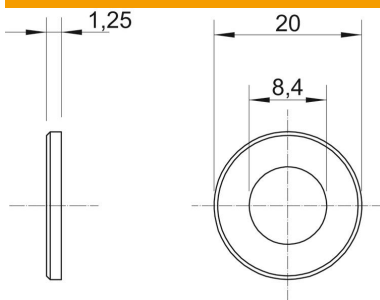

Plate thickness	0.06 in
Dimension D	0.79 in
Dimension d	0.33 in
Dimension d	8.4 mm
Dimension d max.	20 mm
Dimension d min.	20 mm
Dimension h	1.25 mm

Technical data

Thread	M8
Material thickness	1.5 mm