

Technical data sheet

Sealing plug

Item number: 2003737



Sealing plug to close empty pipes.



TPE Thermoplastic elastomer

Master data

Item number	2003737
Type	ZA 20-VS
Description 1	Sealing plug
Description 2	for M20, airtight
Available from	01.10.2021
Manufacturer	OBO
Dimension	Ø20
Colour	Grey
Material	Thermoplastic elastomer
Smallest sales unit	25
Unit of quantity	Piece
Weight	0.17 kg
Weight unit	kg/100 pc.

Technical data sheet

Sealing plug

Item number: 2003737



Dimensions

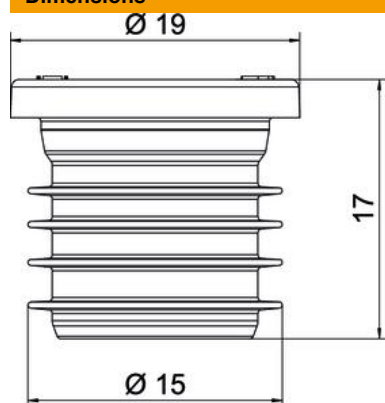

Dimension D1	19 mm
Dimension D2	15 mm
Dimension L	17 mm

Technical data

Flame-resistant	Acc. to VDE 0471/IEC 60695-2-11, test temperature 850°C
Suitable for metric thread dimension	20
Airtight	yes